

# AN HEURISTIC INTRODUCTION TO RADIOASTRONOMICAL POLARIZATION

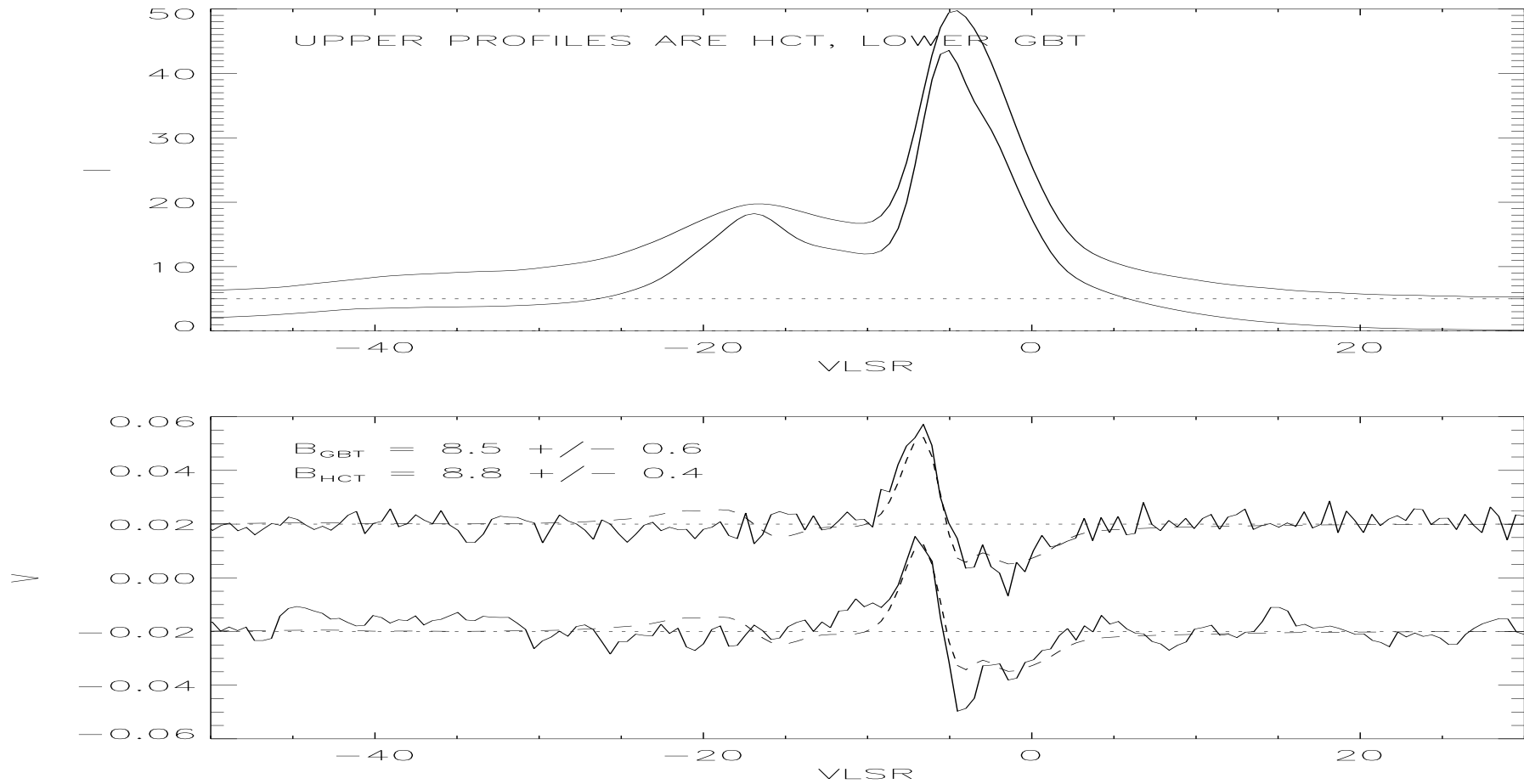
CARL HEILES

Astronomy Department, UC Berkeley

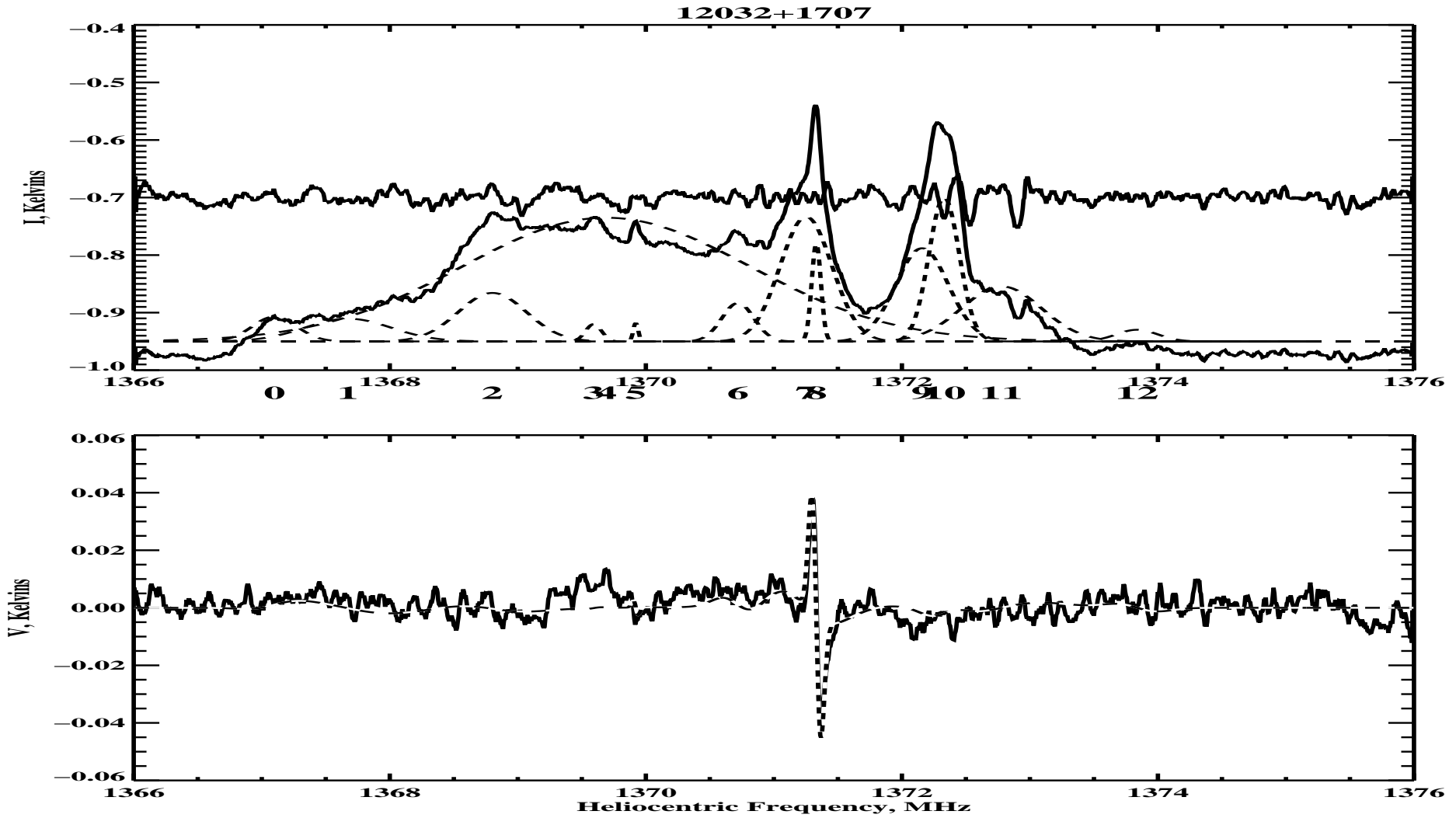
# OUTLINE

- Polarization: the unique probe of magnetic fields in the Universe
- Quantifying polarization with Stokes parameters
- Radio beats optical: We measure all Stokes parameters simultaneously
- The Mueller Matrix relates the CAL to the SKY
- The receiver system introduces calibratable effects in both gain and phase
- Beam effects: squint, squash, more distant sidelobes—Arecibo and GBT
- Why is our Nature paper on DLA Zeeman splitting wrong?
- My website: a paradise of tutorials and documentation
- Three things to remember

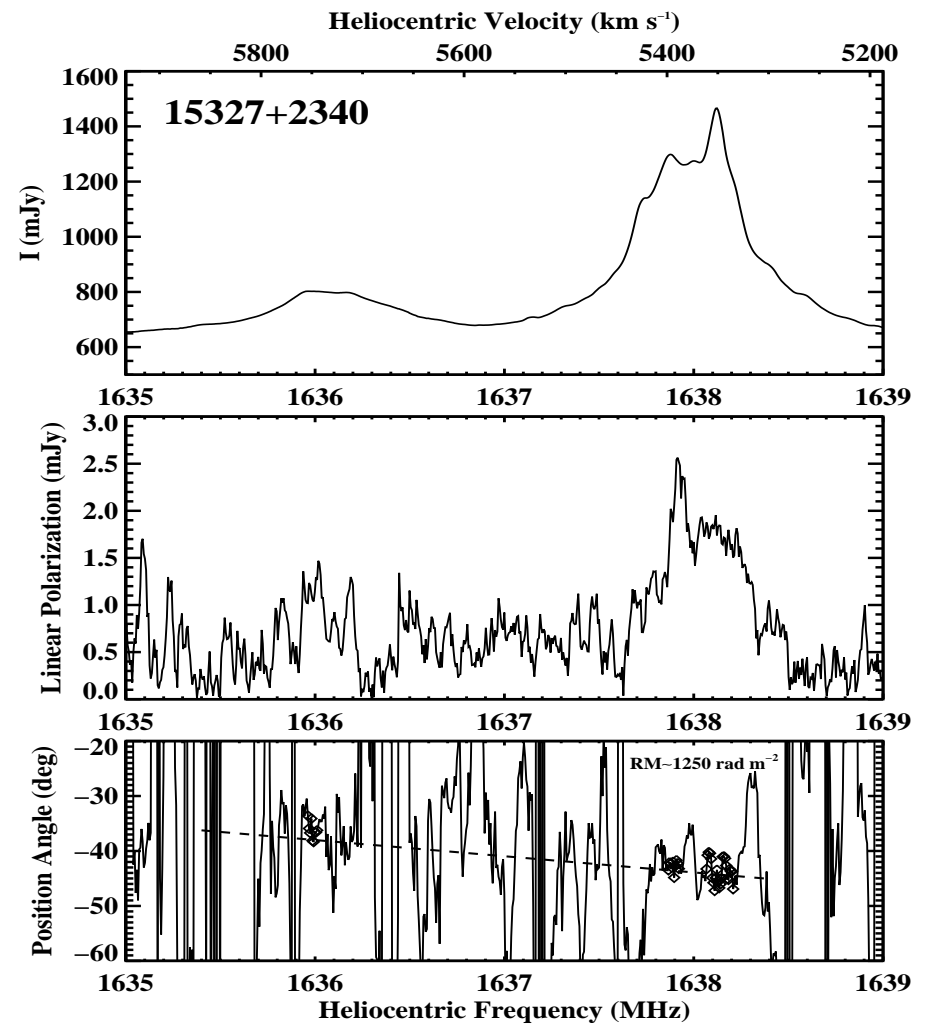
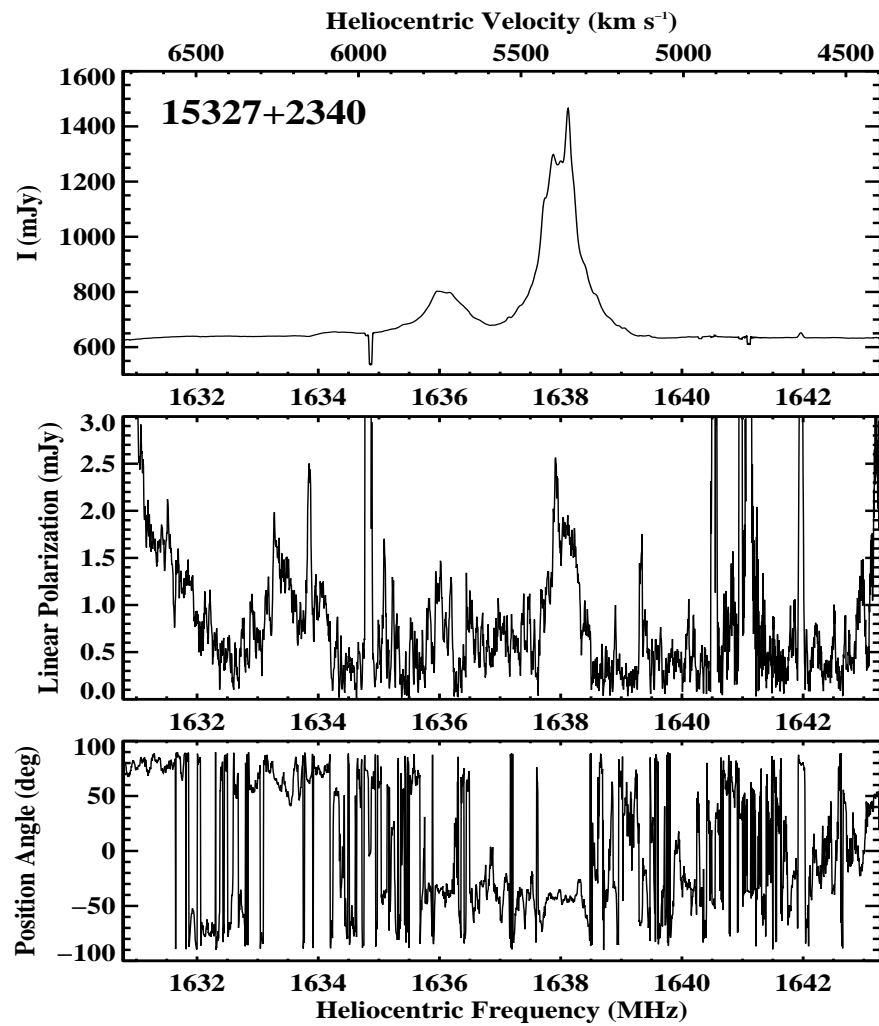
# **POLARIZATION** provides unique information on magnetic fields and esoteric radiative-transfer physics!! **ZEEMAN SPLITTING** — **Stokes V, Galactic HI at the NCP**



# Zeeman Splitting — Stokes V, OH Megamaser in a distant ULIRG



# LINEAR polarization — Fractional Pol and Position Angle, OH Megamaser in a less-distant ULIRG



## Understanding radio polarimetry. III. Interpreting the IAU/IEEE definitions of the Stokes parameters

J.P. Hamaker and J.D. Bregman

Netherlands Foundation for Research in Astronomy, Postbus 2, 7990 AA Dwingeloo, The Netherlands

Received September 26; accepted October 22, 1995

**Abstract.** — In two companion papers (Paper I, Hamaker et al. 1996; Paper II, Sault et al. 1996), a new theory of radio-interferometric polarimetry and its application to the calibration of interferometer arrays are presented. To complete our study of radio polarimetry, we examine here the definition of the Stokes parameters adopted by Commission 40 of the IAU (1974) and the way this definition works out in the mathematical equations. Using the formalism of Paper I, we give a simplified derivation of the frequently-cited ‘black-box’ formula originally derived by Morris et al. (1964). We show that their original version is in error in the sign of Stokes  $V$ , the correct sign being that given by Weiler (1973) and Thompson et al. (1986).

**Key words:** methods: analytical — methods: data analysis — techniques: interferometers — techniques: polarimeters — polarization

### 1. Introduction

In a companion paper (Hamaker et al. 1996, Paper I) we have presented a theory that describes the operation of a polarimetric radio interferometer in terms of the properties of its constituent elements and in doing so unifies the heretofore disjoint realms of radio and optical polarimetry. In a second paper (Sault et al., Paper II) we apply this theory along with theorems borrowed from optical polarimetry to the problem of calibrating an interferometer array such as an aperture-synthesis telescope.

In practical applications, the theory must be supplemented by precise definitions of the coordinate frames and the Stokes parameters that are used. This problem was first addressed by the Institute of Radio Engineers in 1942; the most recent version of their definition was published in 1969 (IEEE 1969). For radio-astronomical applications, the IAU (1974) endorses the IEEE standard, supplementing it with definitions of the Cartesian coordinate frame shown in Fig. 1 and of the sign of the Stokes parameter  $V$ .

Most published work on actual polarimetric interferometer observations infers the source’s Stokes-parameter brightness distributions from a formula derived by Morris et al. (1964). Weiler (1973) rederives their result, agreeing except for the sign of Stokes  $V$ . Thompson et al. (1987)

include his version in their textbook, even though they suggest in their wording that they agree with Morris et al. Clearly the situation needs to be clarified; starting from a complete interpretation of the definitions, we are in a good position to do so. We shall show Weiler’s version indeed to be the correct one.

### 2. The Stokes parameters in a single point in the field

The definition of the Stokes parameters most frequently found in the literature is in terms of the auto- and cross-correlations of the  $x$  and  $y$  components of the oscillating electrical field vectors in a Cartesian frame whose  $z$  axis is along the direction of propagation. Following the notation of Paper I, we represent the components of the electric field by their time-varying complex amplitudes  $e_x(t)$ ,  $e_y(t)$ . The Stokes parameters are then customarily defined by (e.g. Born & Wolf; Thompson et al. 1986):

$$\begin{aligned} I &= \langle |e_x|^2 + |e_y|^2 \rangle \\ Q &= \langle |e_x|^2 - |e_y|^2 \rangle \\ U &= 2 \langle |e_x||e_y| \cos \delta \rangle \\ V &= 2 \langle |e_x||e_y| \sin \delta \rangle \end{aligned} \quad (1)$$

Their equation (1):

$$I = \langle |e_x|^2 + |e_y|^2 \rangle$$

$$Q = \langle |e_x|^2 - |e_y|^2 \rangle$$

$$U = 2 \langle |e_x||e_y| \cos \delta \rangle$$

$$V = 2 \langle |e_x||e_y| \sin \delta \rangle$$

(The four **STOKES PARAMETERS**). They look *awfully* complicated...

But it's not *that* complicated!

Stokes parameters are linear combinations of power measured in *orthogonal polarizations*. There are four:

$$I = E_X^2 + E_Y^2 = E_{0^\circ}^2 + E_{90^\circ}^2$$

$$Q = E_X^2 - E_Y^2 = E_{0^\circ}^2 - E_{90^\circ}^2$$

$$U = E_{45^\circ}^2 - E_{-45^\circ}^2$$

$$V = E_{LCP}^2 - E_{RCP}^2$$

We like to write the *Stokes vector*

$$\mathbf{S} = \begin{bmatrix} I \\ Q \\ U \\ V \end{bmatrix} .$$



## STOKES PARAMETERS: BASICS

$$I = E_X^2 + E_Y^2 = E_{0^\circ}^2 + E_{90^\circ}^2$$

$$Q = E_X^2 - E_Y^2 = E_{0^\circ}^2 - E_{90^\circ}^2$$

$$U = E_{45^\circ}^2 - E_{-45^\circ}^2$$

$$V = E_{LCP}^2 - E_{RCP}^2$$

The first, Stokes  $I$ , is total intensity. It is the sum of *any two orthogonal* polarizations<sup>1</sup>.

The second two, Stokes  $Q$  and  $U$ , completely specify linear polarization.

The last, Stokes  $V$ , completely specifies circular polarization.

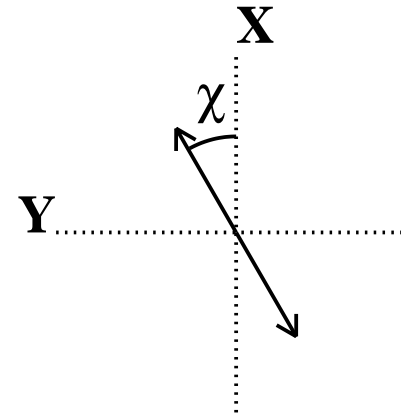
---

<sup>1</sup>Some ill-advised people (like at the **VLA**) define  $I$  as the *average* instead of the *sum*. **BE CAREFUL!**

# CONVENTIONAL LINEAR POL PARAMETERS

$$\frac{Q}{I} = p_{QU} \cos(2\chi)$$

$$\frac{U}{I} = p_{QU} \sin(2\chi)$$



FRACTIONAL LINEAR POLARIZATION:

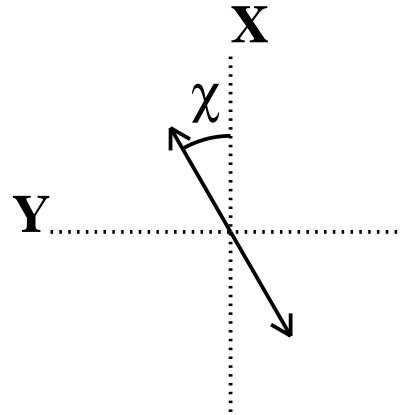
$$p_{QU} = \left[ \left( \frac{Q}{I} \right)^2 + \left( \frac{U}{I} \right)^2 \right]^{1/2}$$

POSITION ANGLE OF LINEAR POLARIZATION:

$$\chi = 0.5 \tan^{-1} \frac{U}{Q}$$

# HEY!!! LINEAR POLARIZATION “DIRECTION” ??

Look at the figure again:



THERE'S NO ARROWHEAD ON THAT “VECTOR”!! That's because it's the angle  $2\chi$ , not  $\chi$ , that's important.

Moral of this story:

- **NEVER** say “linear polarization **DIRECTION**”.
- **INSTEAD**, always say “linear polarization **ORIENTATION**”.

## OTHER CONVENTIONAL POLARIZATION PARAMETERS

FRACTIONAL CIRCULAR POLARIZATION:

$$p_V = \frac{V}{I}$$

TOTAL FRACTIONAL POLARIZATION:

$$p = \left[ \left( \frac{Q}{I} \right)^2 + \left( \frac{U}{I} \right)^2 + \left( \frac{V}{I} \right)^2 \right]^{1/2}$$

If both  $p_{QU}$  and  $p_V$  are nonzero, then the polarization is *elliptical*.

## THE (NON) SENSE OF CIRCULAR POLARIZATION

How is Right-hand Circular Polarization defined?

- If you're a physicist: clockwise as seen by the *receiver*.
- If you're an electrical engineer: the IEEE convention, clockwise as seen by the *transmitter*. *Hey!!! what does the receiver see???*
- If you're a radio astronomer: the technical roots are in microwave engineering, so it's the IEEE convention. Probably!! *You'd better check with your receiver engineers!* Or, to be *really* sure, *measure it yourself* by transmitting a helix from a known vantage point (and remember that  $V$  changes sign when the signal reflects from a surface!).
- If you're an optical astronomer: you read it off the label of the camera and you have no idea (your main goal is the grant money, so getting the science right is too much trouble).

## THE (NON) SENSE OF STOKES $V$

OK... Now that we have RCP straight, how about Stokes  $V$ ?

- If you're a physicist:  $V = RCP - LCP$ .
- If you're an electrical engineer: there's no IEEE convention. Radio astronomers' convention is, historically, from Kraus (e.g. his "ANTENNAS" or his "RADIO ASTRONOMY"):  $V = LCP - RCP$ . *Hey! With Kraus's definition of  $V$ , do physicists and engineers agree???*
- If you're an official of the International Astronomical Union (IAU): The IAU uses the IEEE convention for RCP..., and it defines  $V = RCP - LCP$ , meaning that, for  $V$ , the IAU *differs from both the physicist and the Kraus convention!*

**IS ALL THIS PERFECTLY CLEAR?**

WE'RE NOT THE ONLY ONES WHO ARE CONFUSED! In his thesis, Tim Robishaw traced historical use of  $V$  by astronomers in his thesis. Lets take a look:

(separate pdf file).

## RADIOASTRONOMICAL FEEDS

Feeds are normally designed to approximate pure linear or circular—known as *native linear* or *native circular*.

Generally speaking, native linear feeds are intrinsically accurate and provide true linear. However, *native circular feeds are less accurate and their exact polarization response is frequency dependent.*



At the *GBT*:

- Feeds below 8 GHz are native linear.
- Feeds above 8 GHz are native circular. For the 8-10 GHz receiver, the response changes from pure circular at 8 GHz to 14% elliptical at 10 GHz.

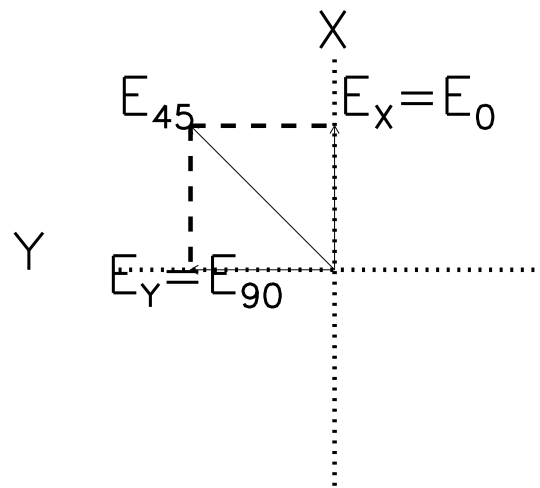
At *ARECIBO*:

- Feeds at 1-2 GHz and 4-6 GHz are native linear. In fact, most feeds are native linear.
- However, a couple are native circular. At Arecibo, circular is achieved with waveguide turnstile junctions, which can be tuned to produce very accurate polarization at the center frequency. However, these are narrow band devices: the feeds become increasingly elliptical, changing to linear and back again over frequency intervals  $\sim 100$  MHz!

# **REAL** RADIO ASTRONOMERS MEASURE ALL STOKES PARAMETERS SIMULTANEOUSLY!

Extracting two orthogonal polarizations provides *all* the information; you can synthesize *all* other E fields from the two measured ones!

Example: Sample  $(E_X, E_Y)$  and synthesize  $E_{45}$  from  $(E_X, E_Y)$ :



To generate  $E_{45}$ , add  $(E_X, E_Y)$  with no phase difference.

To generate  $E_{LCP}$ , add  $(E_X, E_Y)$  with a  $90^\circ$  phase difference.

## CARRYING THROUGH THE ALGEBRA FOR THE TWO LINEARS ...

It's clear that

$$E_{45^\circ} = \frac{E_{0^\circ} + E_{90^\circ}}{\sqrt{2}}$$

$$E_{-45^\circ} = \frac{E_{0^\circ} - E_{90^\circ}}{\sqrt{2}}$$

Write the two linear Stokes parameters:

$$Q = E_X^2 - E_Y^2 = E_{0^\circ}^2 - E_{90^\circ}^2$$

$$U = E_{45^\circ}^2 - E_{-45^\circ}^2 = 2E_X E_Y$$

**STOKES  $U$  IS GIVEN BY THE CROSSCORRELATION  
 $E_X E_Y$**

To get  $V$ , throw a  $90^\circ$  phase factor into the correlation.

## DOTTING THE I'S AND CROSSING THE T'S GIVES...

Carrying through the algebra and paying attention to complex conjugates and extracting the real part of the expressions yields (for sampling linear polarization  $(X, Y)$ ):

$$I = E_X \overline{E_X} + E_Y \overline{E_Y} \equiv \mathbf{XX}$$

$$Q = E_X \overline{E_X} - E_Y \overline{E_Y} \equiv \mathbf{YY}$$

$$U = E_X \overline{E_Y} + \overline{E_X} E_Y \equiv \mathbf{XY}$$

$$iV = E_X \overline{E_Y} - \overline{E_X} E_Y \equiv \mathbf{YX}$$

The overbar indicates the complex conjugate. These products are time averages; we have omitted the indicative  $\langle \rangle$  brackets to avoid clutter.

## IMPORTANT FACT for NATIVE LINEAR FEEDS::

Stokes  $I$  and  $Q$  are the sum and difference of *self-products*. These *self-products* are large—equal to the full system temperature—so  $Q$  is the difference between two large numbers, and is correspondingly inaccurate.

Stokes  $U$  and  $V$  are sums and differences of *cross products*. These *cross products* are small—in fact, in the absence of polarization they should equal *ZERO!* So...

For small polarizations (the usual case!), *cross products are much less subject to error than self-products.*

### COROLLARY:

To accurately measure small *linear* polarization, use a dual *circular* feed (for which  $Q$  and  $U$  are cross products); to accurately measure small *circular* polarization, use a dual *linear* feed (for which  $V$  is a cross product).

## THE MUELLER MATRIX

The output terminals of a native linear feed provides voltages that sample the E-fields  $E_X$  and  $E_Y$ ; this it provides directly the Stokes parameters  $I$  (from  $\mathbf{XX} + \mathbf{YY}$ ) and  $Q$  (from  $\mathbf{XX} - \mathbf{YY}$ ).

Rotating the feed by  $45^\circ$  interchanges  $\mathbf{XX}$  and  $\mathbf{YY}$ , so it provides directly  $I$  and  $U$ .

A native circular feed adds a  $90^\circ$  phase to  $X$  (or  $Y$ ) and provides directly the Stokes parameters  $I$  (from  $\mathbf{XX} + \mathbf{YY}$ ) and  $V$  (from  $\mathbf{XX} - \mathbf{YY}$ ). We express these interchanges of power among Stokes parameters with the *Mueller matrix*  $\mathbf{M}$ .

$$\begin{bmatrix} \mathbf{XX} \\ \mathbf{YY} \\ \mathbf{XY} \\ \mathbf{YX} \end{bmatrix} = \mathbf{M} \cdot \begin{bmatrix} I \\ Q \\ U \\ V \end{bmatrix} \quad (1)$$

Some examples of Mueller matrices:

**(1)** A dual linear feed:  $\mathbf{M}$  is unitary.

**(2).** A dual linear feed rotated  $45^\circ$ :  $Q$  and  $U$  interchange, together with a sign change as befits rotation:

$$\mathbf{M} = \begin{bmatrix} 1 & 0 & 0 & 0 \\ 0 & 0 & 1 & 0 \\ 0 & -1 & 0 & 0 \\ 0 & 0 & 0 & 1 \end{bmatrix} . \quad (2)$$

**(3).** A dual linear feed rotated  $90^\circ$ , which reverses the signs of  $Q$  and  $U$ :

$$\mathbf{M} = \begin{bmatrix} 1 & 0 & 0 & 0 \\ 0 & -1 & 0 & 0 \\ 0 & 0 & -1 & 0 \\ 0 & 0 & 0 & 1 \end{bmatrix} . \quad (3)$$

(4) The above are special instructive cases. As an alt-az telescope tracks a source, the feed rotates on the sky by the *parallactic angle*  $PA_{az}$  (What's *that?*).

$$\mathbf{M}_{\mathbf{SKY}} = \begin{bmatrix} 1 & 0 & 0 & 0 \\ 0 & \cos 2PA_{az} & \sin 2PA_{az} & 0 \\ 0 & -\sin 2PA_{az} & \cos 2PA_{az} & 0 \\ 0 & 0 & 0 & 1 \end{bmatrix} . \quad (4)$$

The central  $2 \times 2$  submatrix is, of course, nothing but a rotation matrix.  $\mathbf{M}_{\mathbf{SKY}}$  doesn't change  $I$  or  $V$ .

(5). A dual circular feed, for which  $V = \mathbf{XX} - \mathbf{YY}$ :

$$\mathbf{M} = \begin{bmatrix} 1 & 0 & 0 & 0 \\ 0 & 0 & 0 & 1 \\ 0 & 0 & 1 & 0 \\ 0 & -1 & 0 & 0 \end{bmatrix} . \quad (5)$$



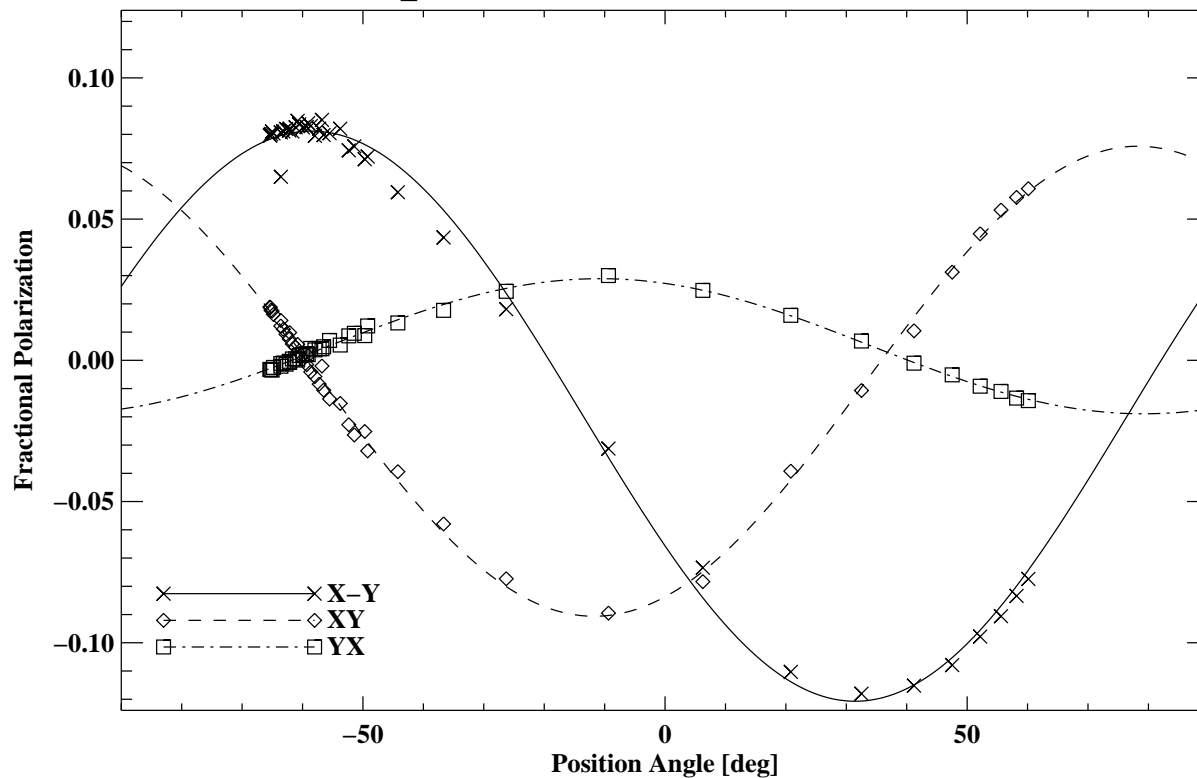
For a perfect system that has  $\mathbf{M}$  unitary, as we track a linearly polarized source across the sky the parallactic angle  $PA$  changes. This should produce:

- For  $\mathbf{XX} - \mathbf{YY}$ ,  $[\cos 2(PA_{AZ} + PA_{SRC})]$  centered at zero;
- For  $\mathbf{XY}$ ,  $[\sin 2(PA_{AZ} + PA_{SRC})]$  centered at zero;
- For  $\mathbf{YX}$ , zero (most sources have zero circular polarization).

The extent to which these idealizations are not realized defines the Mueller matrix elements.

Let's look at some *real data*: first native linear, then native circular.

Rcvr1\_2 1420 MHz BRD0 3C286 3-AUG-2003



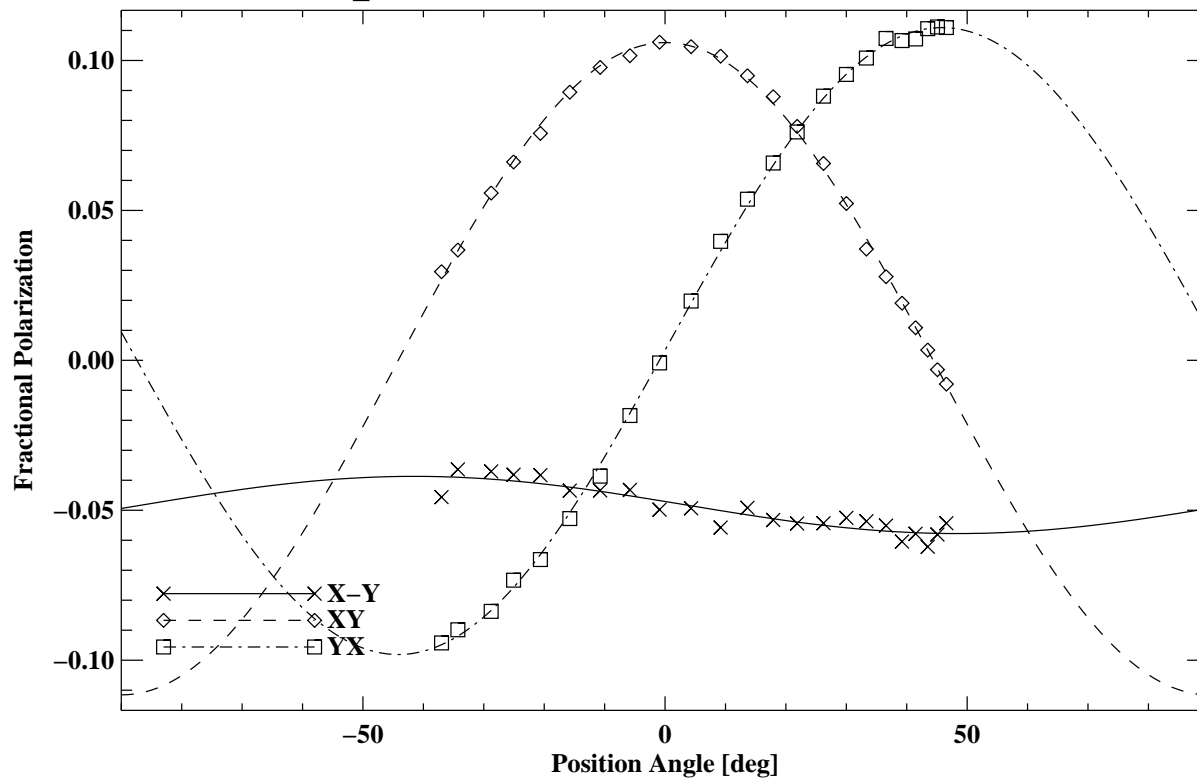
**DELTA<sub>G</sub> = -0.040 ± 0.016**  
**PSI = -16.0 ± 4.8**  
**ALPHA = +0.2 ± 2.4**  
**EPSILON = 0.004 ± +0.004**  
**PHI = +162.1 ± 50.3**  
**Q<sub>SRC</sub> = -0.040 ± 0.006**  
**U<sub>SRC</sub> = -0.085 ± 0.006**  
**POL<sub>SRC</sub> = +0.094 ± 0.000**  
**PA<sub>SRC</sub> (\*\*UNCORRECTED FOR M<sub>ASTRO</sub> \*\*) = -57.7 ± 0.0**  
**NR GOOD POINTS: X-Y = 41 XY = 42 YX = 42 / 42**  
**SCAN 26**

---

**Mueller Matrix:**

1.0000	-0.0198	-0.0085	0.0026
-0.0198	1.0000	0.0002	0.0075
-0.0074	-0.0021	0.9612	0.2760
0.0050	-0.0073	-0.2760	0.9611

**Rcvr8\_10 10000 MHz BRD0 SP 3C138 12-JAN-2003**



**DELTA<sub>G</sub> = -0.096 ± 0.004**  
**PSI = +0.0 ± 0.0**  
**ALPHA = -47.6 ± 0.5**  
**EPSILON = +0.004 ± 0.001**  
**PHI = +113.5 ± 18.2**  
**Q<sub>SRC</sub> = -0.002 ± 0.001**  
**U<sub>SRC</sub> = +0.107 ± 0.001**  
**POL<sub>SRC</sub> = +0.107 ± 0.001**  
**PA<sub>SRC</sub> (\*\*UNCORRECTED FOR M<sub>ASTRO</sub> \*\*) = +45.47 ± 0.38**  
**NR GOOD POINTS: X-Y = 23 XY = 23 YX = 23 / 23**

-----  
**Mueller Matrix:**

<b>1.0000</b>	<b>0.0107</b>	<b>-0.0028</b>	<b>0.0475</b>
<b>-0.0482</b>	<b>-0.0903</b>	<b>0.0001</b>	<b>-0.9959</b>
<b>-0.0028</b>	<b>-0.0000</b>	<b>1.0000</b>	<b>0.0000</b>
<b>0.0064</b>	<b>0.9959</b>	<b>0.0000</b>	<b>-0.0900</b>

# THE SINGLE MATRIX FOR THE RADIOASTRONOMICAL RECEIVER

The observing system consists of several distinct elements, each with its own Mueller matrix. The matrix for the whole system is the product of all of them. Matrices are not commutative, so we must be careful with the order of multiplication.

$$\mathbf{M}_{\text{TOT}} = \begin{bmatrix} 1 & (-2\epsilon \sin \phi \sin 2\alpha + \frac{\Delta G}{2} \cos 2\alpha) & 2\epsilon \cos \phi & (2\epsilon \sin \phi \cos 2\alpha + \frac{\Delta G}{2} \sin 2\alpha) \\ \frac{\Delta G}{2} & \cos 2\alpha & 0 & \sin 2\alpha \\ 2\epsilon \cos(\phi + \psi) & \sin 2\alpha \sin \psi & \cos \psi & -\cos 2\alpha \sin \psi \\ 2\epsilon \sin(\phi + \psi) & -\sin 2\alpha \cos \psi & \sin \psi & \cos 2\alpha \cos \psi \end{bmatrix} .$$

NOTE: The Mueller matrix has 16 elements, but *ONLY 7 INDEPENDENT PARAMETERS*. The matrix elements are not all independent.

$\Delta\mathbf{G}$  is the error in relative intensity calibration of the two polarization channels. It results from an error in the relative cal values  $(T_{calA}, T_{calB})$ .

$\psi$  is the phase difference between the cal and the incoming radiation from the sky (equivalent in spirit to  $L_X - L_Y$  on our block diagram..

$\alpha$  is a measure of the voltage ratio of the polarization ellipse produced when the feed observes pure linear polarization.

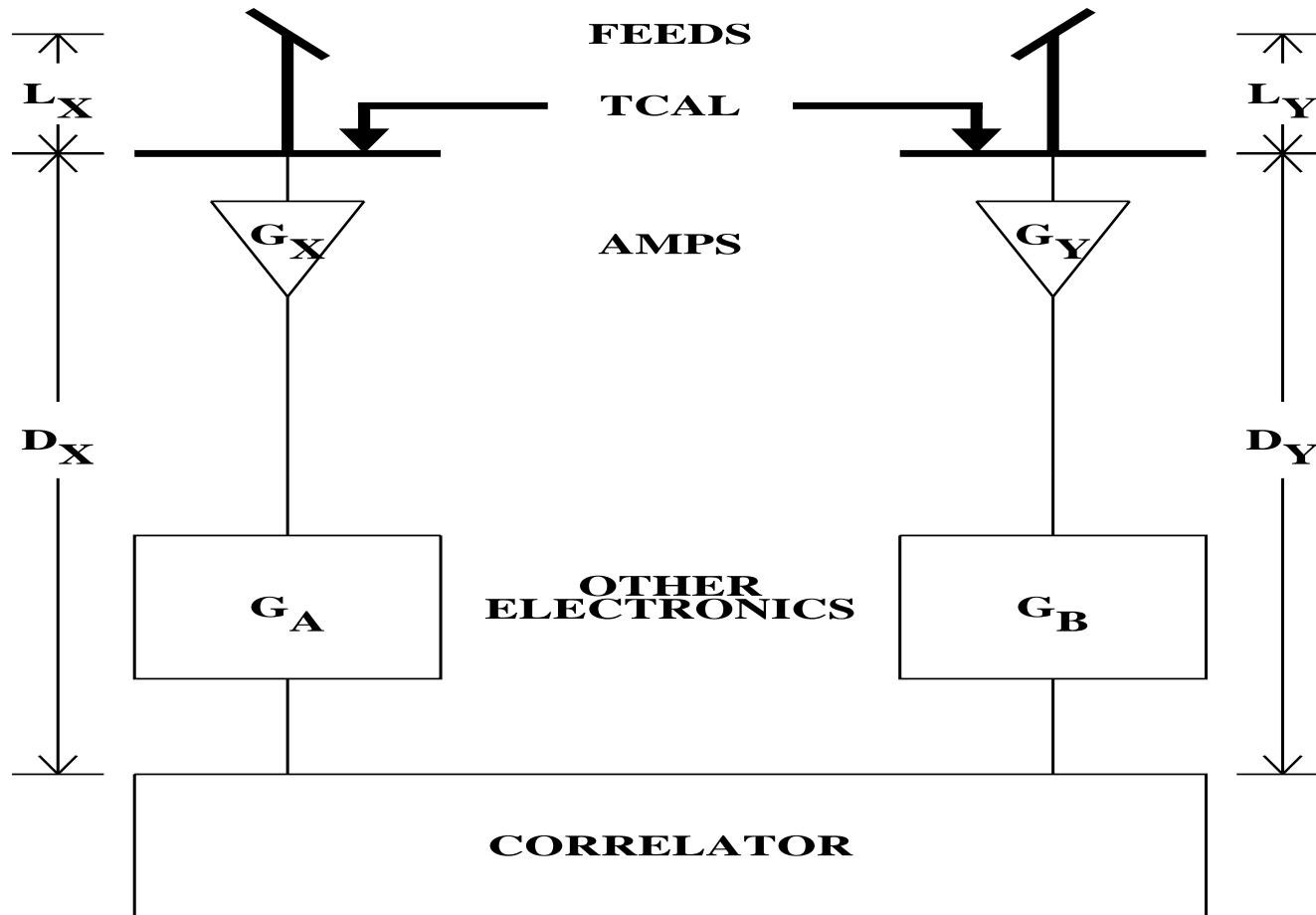
$\chi$  is the relative phase of the two voltages specified by  $\alpha$ .

$\epsilon$  is a measure of imperfection of the feed in producing nonorthogonal polarizations (false correlations) in the two correlated outputs.

$\phi$  is the phase angle at which the voltage coupling  $\epsilon$  occurs. It works with  $\epsilon$  to couple  $I$  with  $(Q, U, V)$ .

$\theta_{astron}$  is the angle by which the derived position angles must be rotated to conform with the conventional astronomical definition.

THE MUELLER MATRIX REFERS ONLY TO THE THICK CIRCUIT BELOW (RELATES CAL TO SKY)



THE THIN CIRCUIT IS EASIER: NO COUPLING!  
EACH CHANNEL HAS A GAIN AND PHASE

## THE CAL...OUR CONVENIENT INTENSITY AND PHASE REFERENCE

We determine the Mueller matrix elements by comparing the cal deflection with the deflection of an astronomical source of known polarization (i.e., a “polarization calibrator”; the best is 3C286). **THIS CALIBRATES THE THICK CIRCUIT**

The signal and cal share common paths below its injection point (thin circuit). The thin circuit affects both equally. We use the cal to determine the properties of the thin circuit, minute-by-minute (or whatever).

## THE THIN CIRCUIT HAS ACTIVE ELEMENTS AND IS THUS TIME-VARIABLE

Amplifier gains are *complex*: **amplitude (GAIN)** and **PHASE**.

The **GAIN** calibration is just like *ordinary nonpolarized observations*.

The **PHASE** calibration... It's the **PHASE DIFFERENCE** that matters. Cable lengths introduce phase delays. Cables are never identical!

Since

$$\Delta\phi = \frac{2\pi(D_X - D_Y)}{\lambda},$$

**THE PHASE DIFFERENCE DEPENDS ON FREQUENCY!**

$$\frac{d\Delta\phi}{df} = \frac{2\pi \Delta D}{c} \approx 0.3 \frac{\text{rad}}{\text{MHz}}$$

(At Arecibo; it's almost as large for the GBT). This corresponds to

$$\Delta D \approx 20 \text{ m} \text{ !!!!!}$$



## THIS HAS CONSEQUENCES!

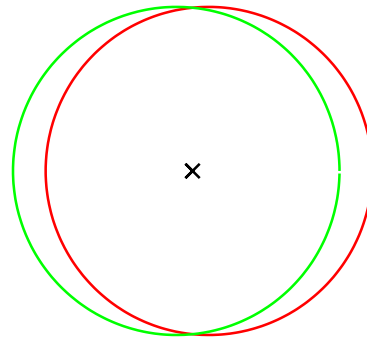
- You must include the frequency dependence when you calibrate your data. This is a bit tricky.
- You cannot do continuum polarization over significant bandwidths without including  $\frac{d\Delta\phi}{df}$ . In particular, continuum observing usually uses large bandwidth—and the phase can easily wrap over multiple  $2\pi$  intervals. **DISASTER! EVEN POLARIZED SOURCES WILL APPEAR UNPOLARIZED!!**

# POLARIZED BEAM EFFECTS: BEAM SQUINT

BEAM SQUINT

LHC

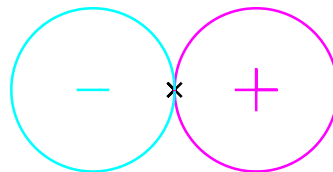
RHC



$$V = \text{LHC} - \text{RHC}$$

$$V > 0$$

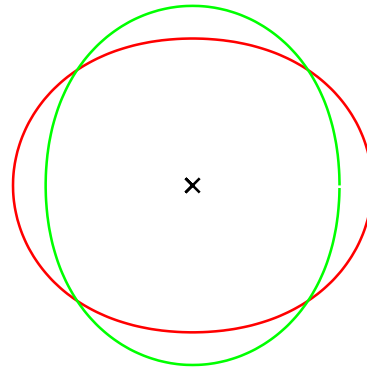
$$V < 0$$



# POLARIZED BEAM EFFECTS: BEAM SQUASH

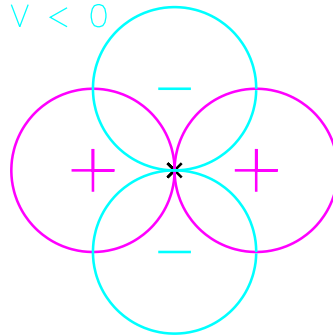
BEAM SQUASH

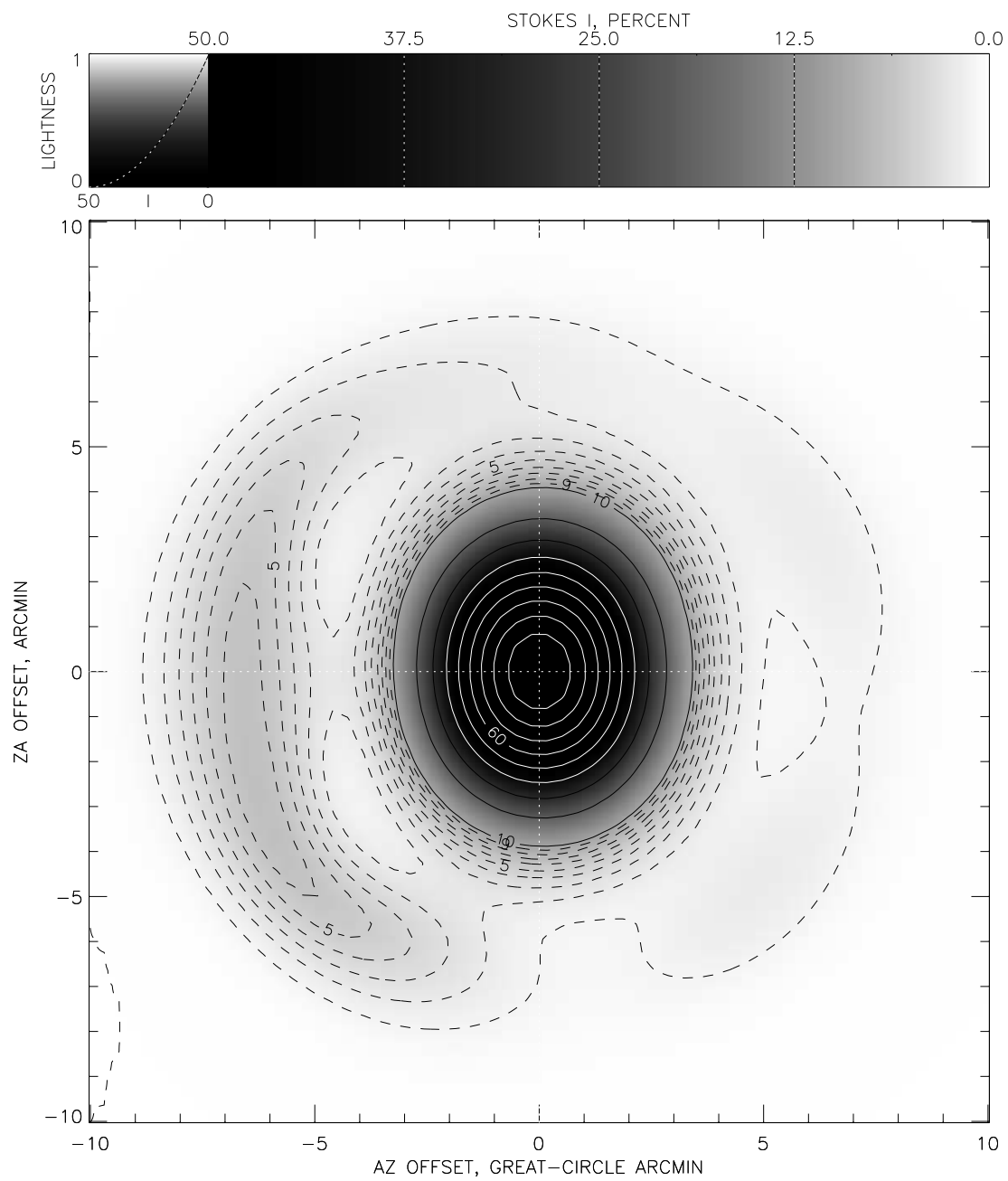
LHC  
RHC

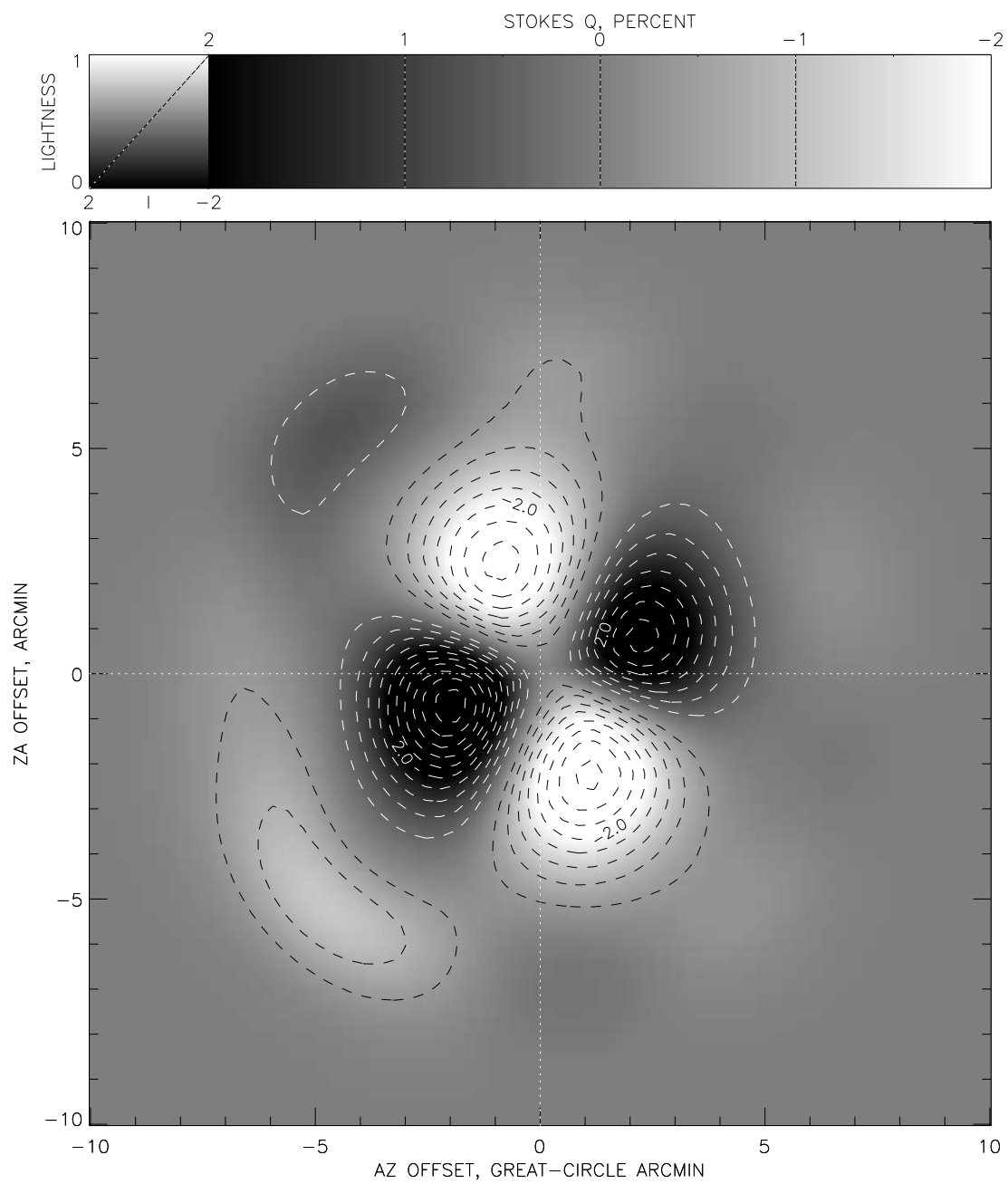


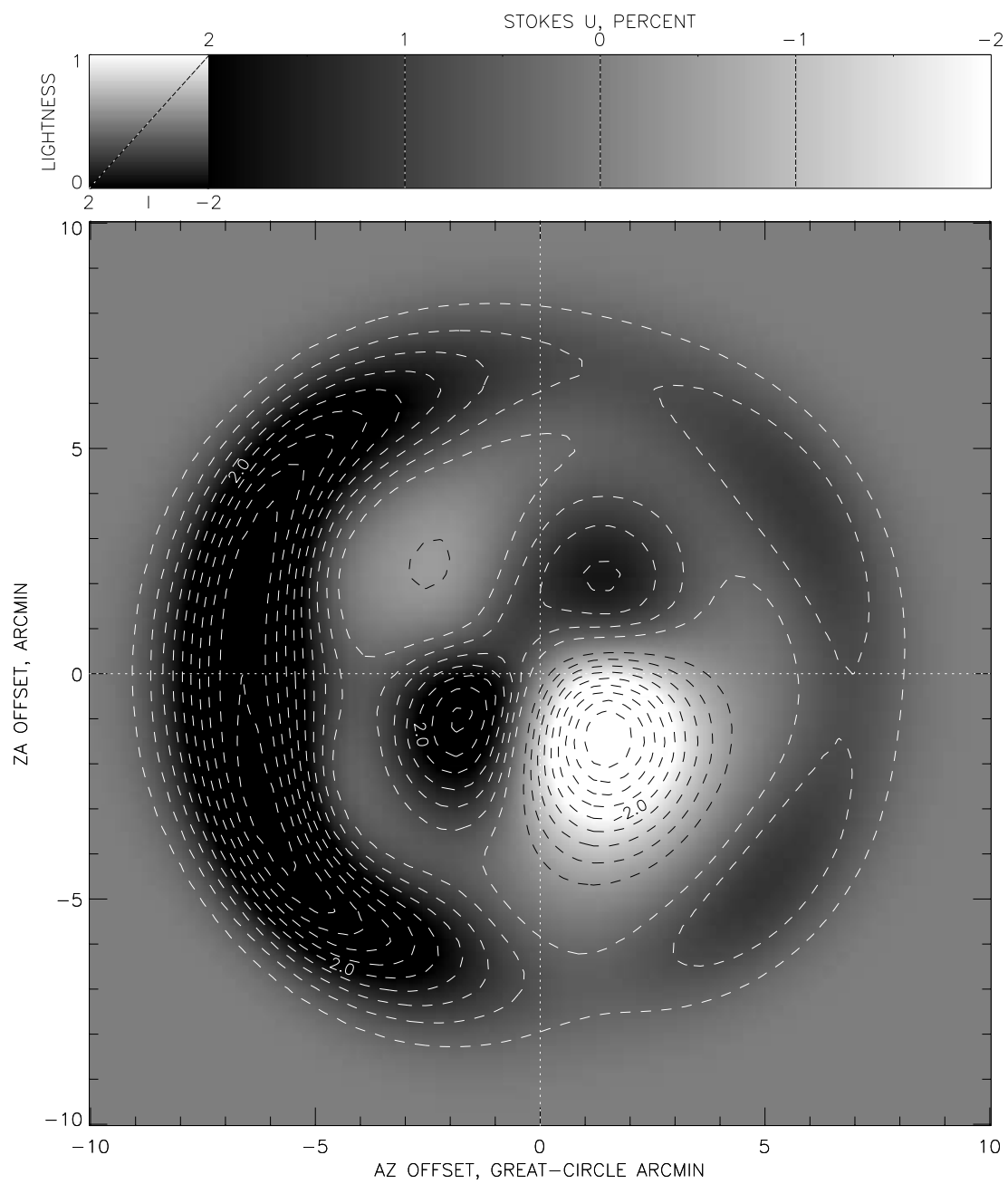
$V = \text{LHC} - \text{RHC}$

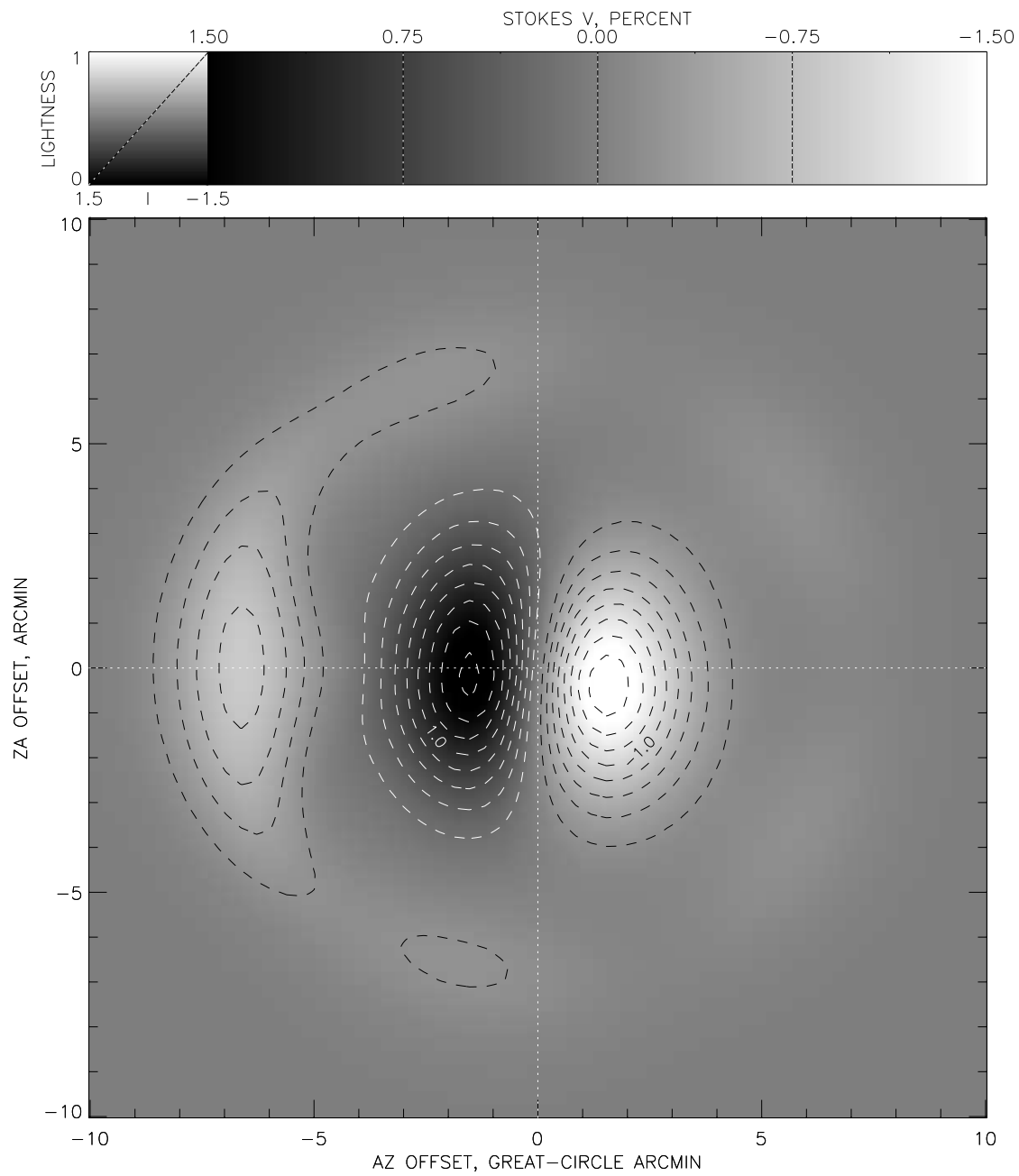
$V > 0$   
 $V < 0$



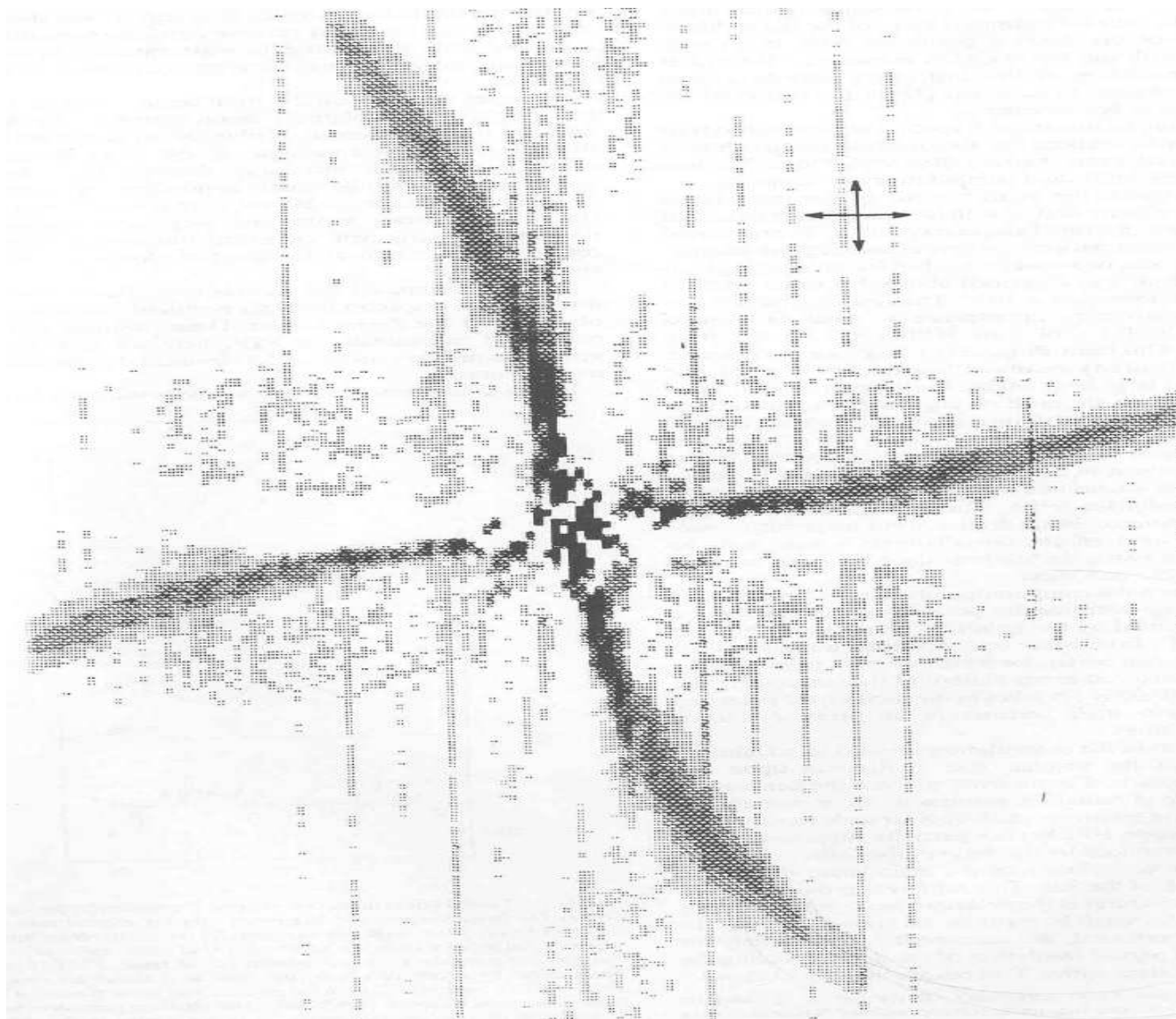








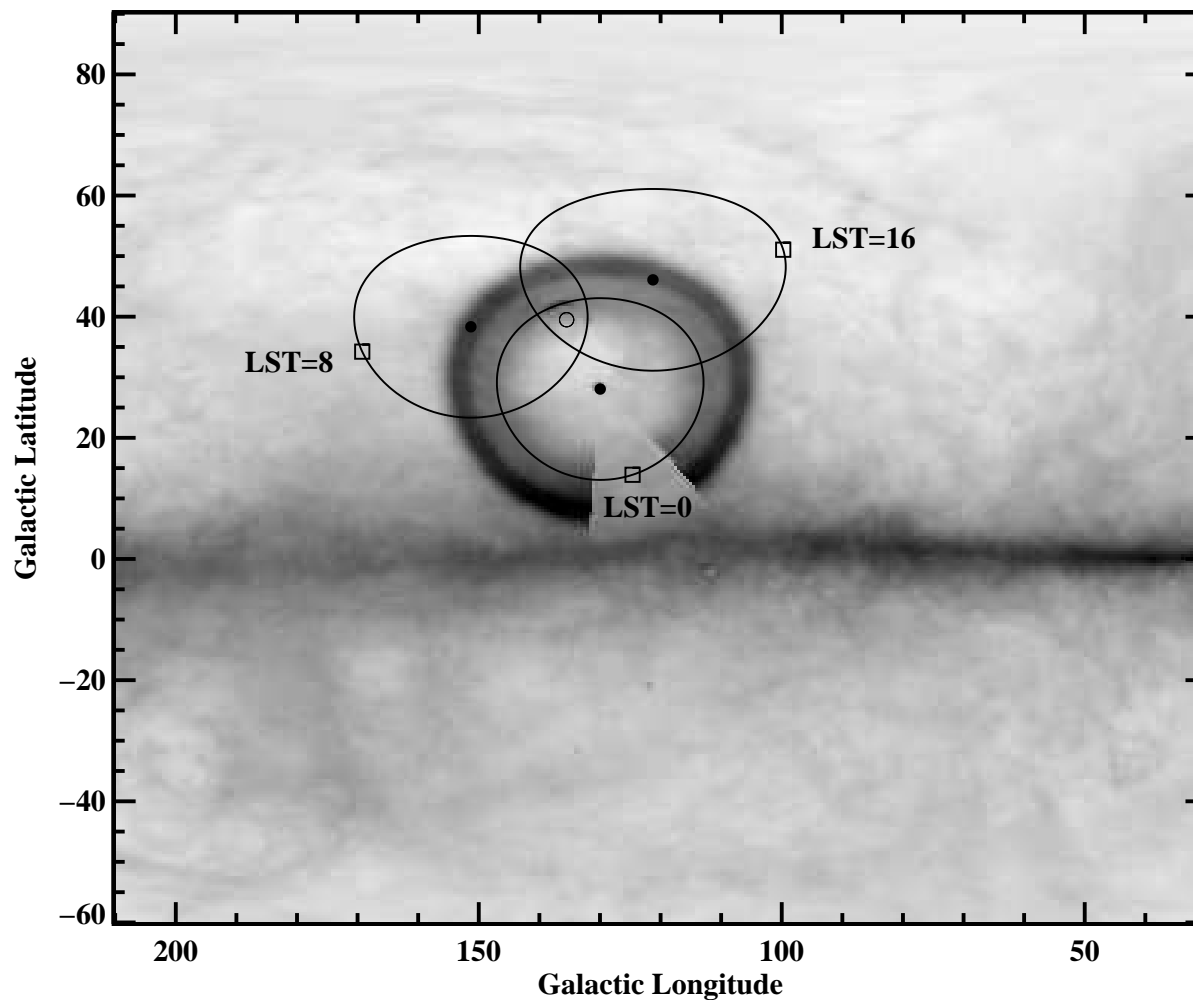
# POLARIZED BEAM EFFECTS: DISTANT SIDELOBES



(Stokes  $V$  from the Hat Creek 85-footer. Image is  $120^\circ \times 120^\circ$ )



Even the GBT is not sidelobe-free. Here's an approximate image of the secondary spillover in Stokes  $I$ —and there are also serious near-in lobes. All are *highly polarized!!!* (Robishaw & Heiles 2009, PASP, 121, 272)



# THE EFFECT ON ASTRONOMICAL POLARIZATION MEASUREMENTS

Large-scale features have spatial structure of *Stokes I*. Sidelobes in Stokes *Q*, *U*, and *V* see this structure. The polarized beam structure interacts with the Stokes *I* derivatives to produce **FAKE RESULTS** in the *polarized* Stokes parameters (*Q*, *U*, *V*).

Correcting for these effects is a complicated business. First, you have to measure them; they are weak, so this is difficult. (At the GBT, Robishaw and Heiles (2009) used the Sun.) They may well be time variable, particularly at Arecibo where the telescope geometry changes as the telescope tracks. Finally, the polarized sidelobes rotate on the sky as the parallactic angle changes—and distant sidelobes might see the ground instead of the sky.

**IT'S REALLY HARD TO ACCURATELY MEASURE  
POLARIZATION OF EXTENDED EMISSION!!**

# WHY IS OUR NATURE PAPER WRONG?

nature

Vol 455|2 October 2008|doi:10.1038/nature07264

## LETTERS

---

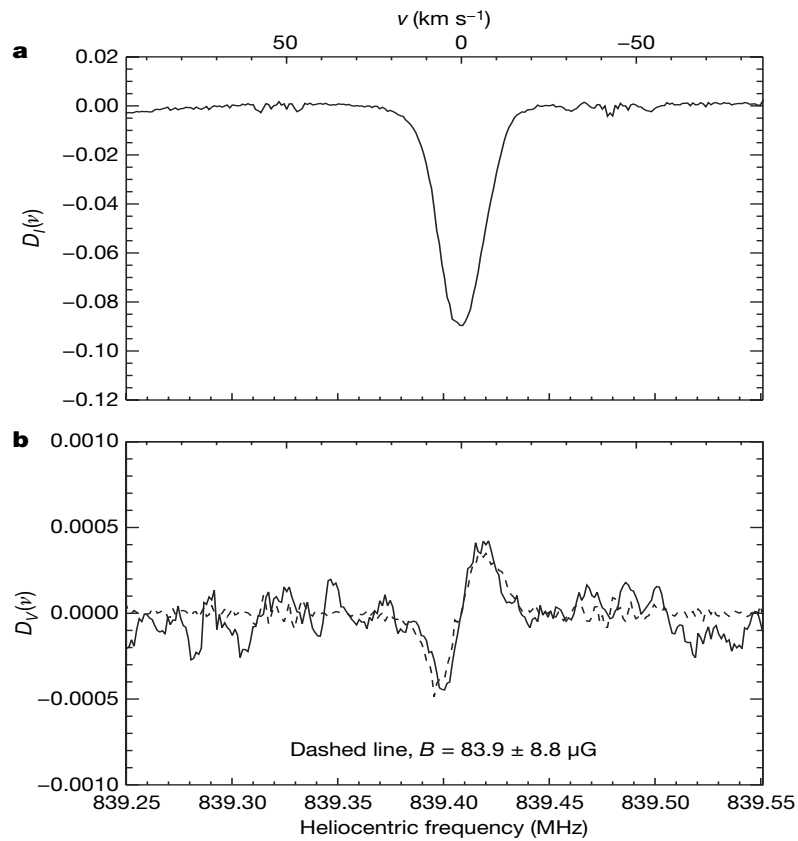
### An 84- $\mu\text{G}$ magnetic field in a galaxy at redshift $z = 0.692$

Arthur M. Wolfe<sup>1</sup>, Regina A. Jorgenson<sup>1</sup>, Timothy Robishaw<sup>2</sup>, Carl Heiles<sup>2</sup> & Jason X. Prochaska<sup>3</sup>

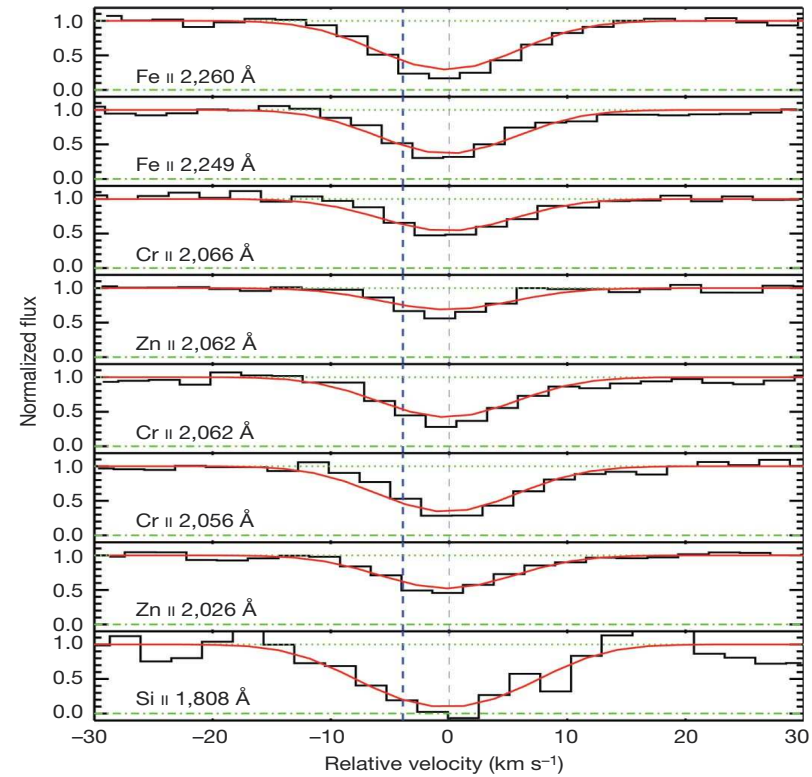
The magnetic field pervading our Galaxy is a crucial constituent of the interstellar medium: it mediates the dynamics of interstellar clouds, the energy density of cosmic rays, and the formation of stars<sup>1</sup>. The field associated with ionized interstellar gas has been determined through observations of pulsars in our Galaxy. Radio-frequency measurements of pulse dispersion and the rotation of the plane of linear polarization, that is, Faraday rotation, yield an average value for the magnetic field of  $B \approx 3 \mu\text{G}$  (ref. 2). The possible detection of Faraday rotation of linearly polarized radio waves

observations of the 21-cm absorption line show that the gas layer must extend across more than  $0.03''$  to explain the difference between the velocity centroids of the fringe amplitude and phase-shift spectra<sup>9</sup> (although the data are consistent with a magnetic field coherence length of less than 200 pc, the resulting gradient in magnetic pressure would produce velocity differences exceeding the shift of  $\sim 3 \text{ km s}^{-1}$  across 200 pc detected by very-long-baseline interferometry). By contrast, the transverse dimensions of radio beams subtended at neutral interstellar clouds in the Galaxy are typically less than 1 arc second. This

715 in DLA-3C286, the magnetized gas cannot be confined by its self-gravity. Therefore, self-consistent magnetostatic configurations are ruled out unless the contribution of stars to  $\Sigma$  exceeds  $\sim 350M_{\odot} \text{ pc}^{-2}$ . Although this is larger than the  $50M_{\odot} \text{ pc}^{-2}$  surface density perpendicular to the solar neighbourhood, such surface densities are common in the central regions of galaxies. In fact, high surface densities of stars probably confine the highly magnetized gas

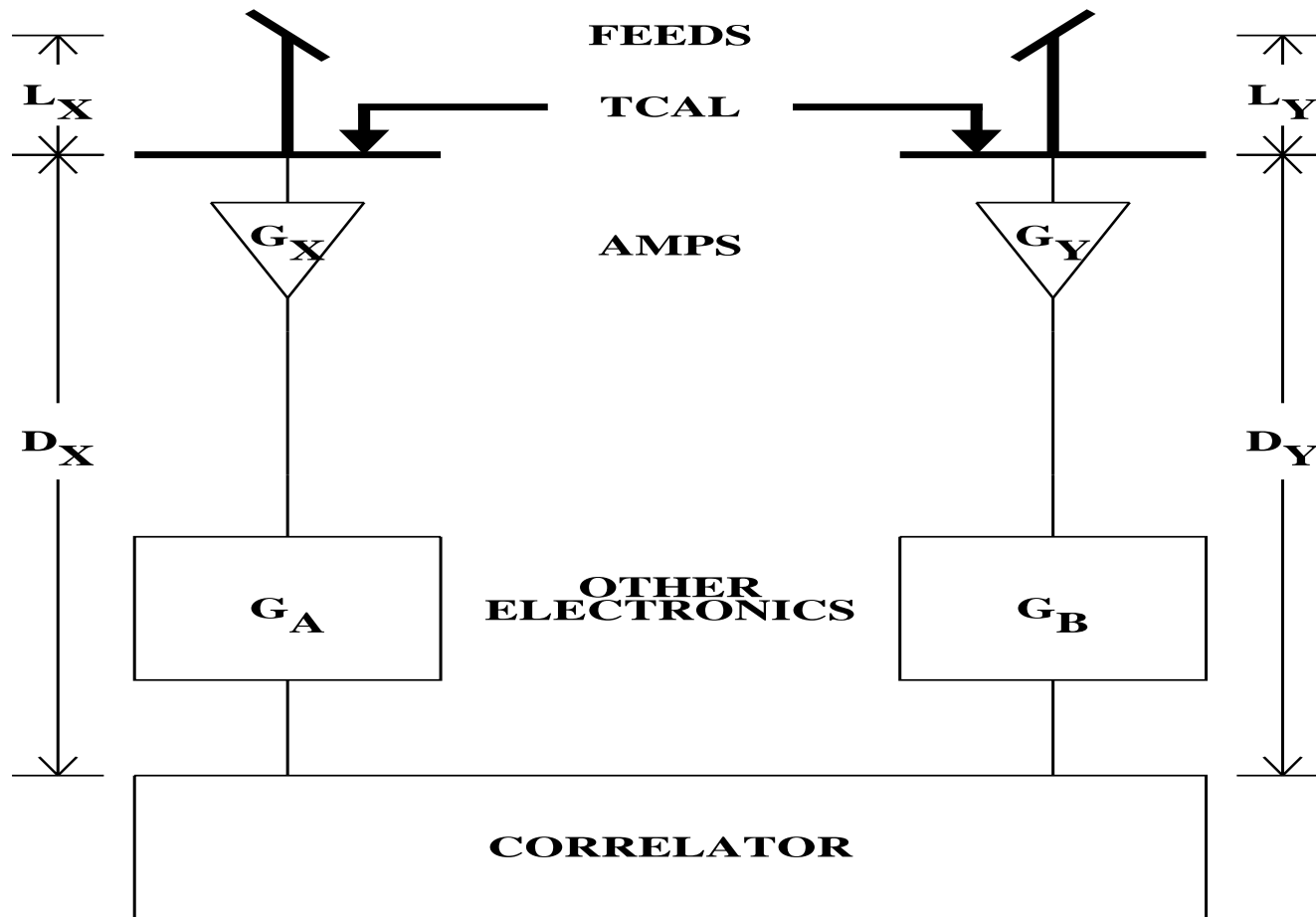


**Figure 1 | Line-depth spectra of Stokes parameters.** Data acquired in 12.6 hours of on-source integration with the GBT radio antenna. Because the GBT feeds detect only orthogonal, linearly polarized signals, whereas Zeeman splitting requires measuring circular polarization to construct  $V(v)$ ,



**Figure 2 | HIRES velocity profiles for dominant low-ionization states of abundant elements in the 21-cm absorber in the direction of quasar 3C 286.** Spectral resolution is  $\Delta v = 7.0 \text{ km s}^{-1}$  and the average signal-to-noise ratio per  $2.1\text{-km-s}^{-1}$  pixel is about 30:1. The bold dashed vertical line denotes the velocity centroid of the single-dish 21-cm absorption feature and the faint dashed vertical lines denotes the velocity centroid of the resonance line shown in the figure. Our least-squares fit of Voigt profiles (red) to the data (black) yields ionic column densities as well as the redshift centroid and velocity dispersion shown in Table 1 (lower and upper green horizontal lines refer to zero and unit normalized fluxes, respectively). Because refractory elements such as Fe and Cr can be depleted onto dust grains<sup>25</sup>, we used the volatile elements Si and Zn to derive a logarithmic metal abundance with respect to solar abundances of  $[M/H] = -1.30$ . The depletion ratios  $[\text{Fe}/\text{Si}]$  and  $[\text{Cr}/\text{Zn}]$  were then used to derive a conservative upper limit on the logarithmic dust-to-gas ratio relative to Galactic values of  $[D/G] < -1.8$ .

It all has to do with that phase difference,  $\Delta\phi$ .



For these measurements, at the frequency of the line, it *just so happened* that  $\Delta\phi \approx 91.7^\circ$ .

## OUR (MY) software had a bug:

When given an array of spectra to correct, it worked fine—but if done one-at-a-time, it *did not correct for this phase*. Since the phase was just about  $90^\circ$ , we *interchanged Stokes U and V*. So our the line wasn't *circularly* polarized; rather, it was *linearly polarized!*

# Here's the bug:

```
pro phasecorr_xyyx, xy, yx, frq, ozero, oslope, xyc, yxc

;+
; NAME:
;     PHASECORR_XYYX
;
; PURPOSE:
;     Given a zero and slope of phase, calculate a corrected version
;
; CALLING SEQUENCE:
;     PHASECAL_CORR, xy, yx, frq, ozero, oslope, xyc, yxc
;
; INPUTS:
;     XY[ nchnls, nspectra], YX [ nchnls, nspectra] the xy and
;     yx...the two correlated outputs from the ; correlator.
;
;     FRQ[ nchls]: the array of frequencies for which OZERO, OSLOPE
;were
;           calculated from PHASECAL_CROSS or some other
;similar
;           program.
;
;     OZERO and OSLOPE - the linear fit coefficients and errors, the
;           units are **** RADIANS ***** and *****
;           RADIANS/MHZ *****. Each is a 2 element
;vector:
;           the first element is the value, the second
;the 1
;           sigma error.
;
; OUTPUTS:
;     XYC, YXC: corrected versions of XY, YX (done according to
;           CORRECTOPTION)
```

```
;
; MODIFICATION HISTORY:
;     05 jun 2009: ch found error; the statement labelled below was
;     wrong, meaning for only one spectrum no correction was done.
;-

xyc= xy
yxc= yx

sz= size( xy)
phase_fit = ozero[0] + oslope[0]*frq

;stop, 'middle'

nrmax= sz[2]
;pre-05jun2009 incorrect version: if sz[ 0] eq 1 then nrmax=0
if sz[ 0] eq 1 then nrmax=1

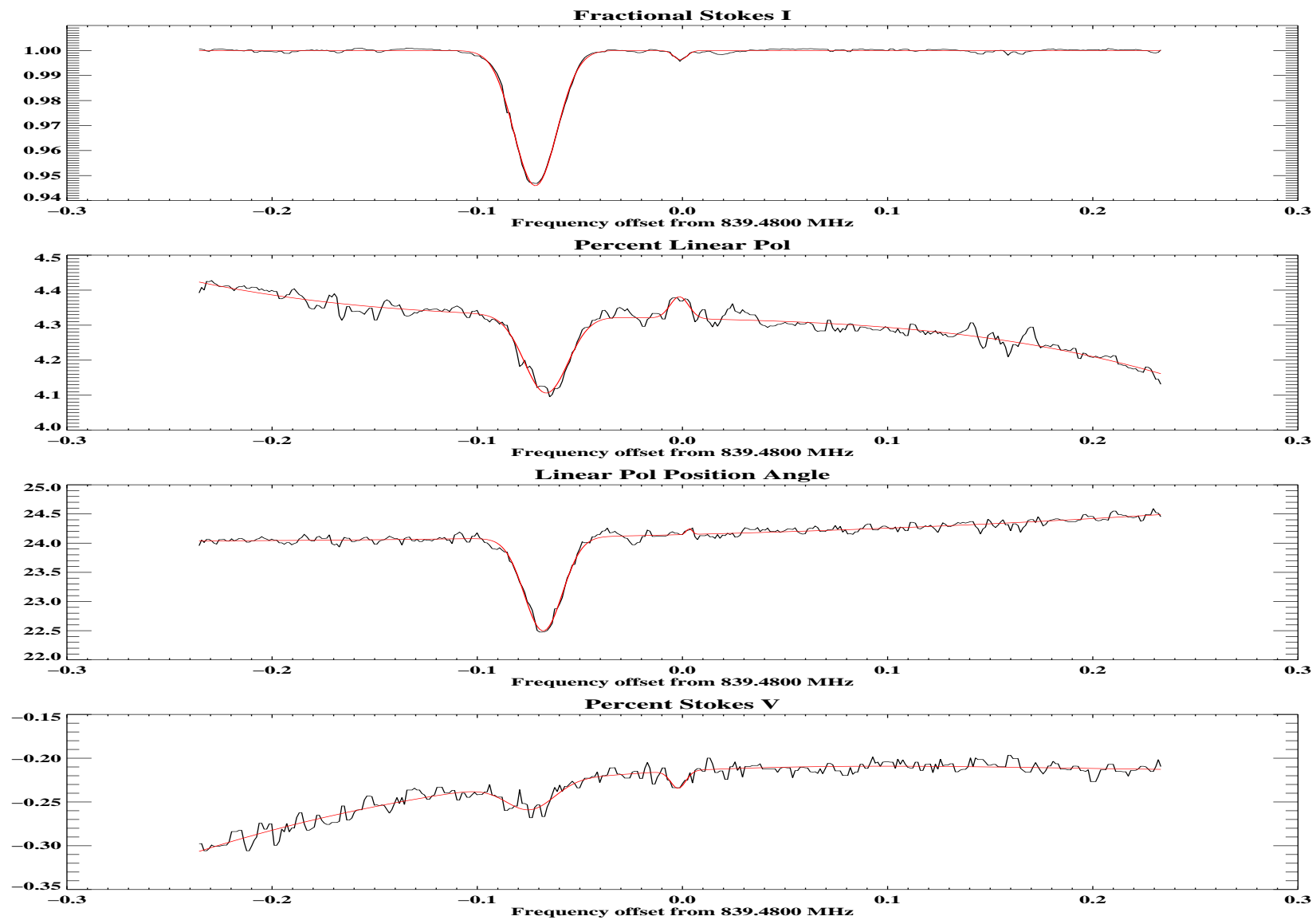
for nr=0, nrmax-1 do begin
    reunrotated = xyc[ *, nr]
    imunrotated = yxc[ *, nr]
    angrotate, reunrotated, imunrotated, (-!radeg*phase_fit), rerotated, imrotated
    xyc[ *, nr] = rerotated
    yxc[ *, nr] = imrotated
endfor

;stop, 'end'

end ; phasecorr_xyyx
```



# THE TRUE ALL-STOKES SET OF SPECTRA:



It's still interesting—but as regards magnetic fields, the field limit is un-interestingly low.

**SOME DOCUMENTATION.** You might find my website useful; it contains instructional handouts and practical IDL software.

<http://astro.berkeley.edu/~heiles/>

It has sections on (a partial list):

- *Radio Astronomical Techniques and Calibration* [specific intensity, spectral lines, polarization, characterizing the telescope beam (including “Spider scans”), LSFS (Least-Squares Frequency Switching)]
- *IDL Procedures and Instructional Handouts* [Introductory tutorial; datatypes]
- Downloading my set of IDL procedures
- *Principles of Imaging and Projections* [Four tutorials, including use of color]
- *Handouts on Numerical Analysis* [Least squares, Fourier, Wavelets]

In addition, we are currently working on two coherent practical writeups of “how to do polarization calibration and data analysis” for the GBT and Arecibo...

# GENERATING MUELLER MATRICES AND ALL-STOKES BEAM PARAMETERS FROM GBT SPIDER OR ON/OFF SCANS WITH THE ROBISHAW/HEILES GBT POLARIZATION (RHGBTPOL) IDL SOFTWARE

DRAFT, May 11, 2009

Carl Heiles, Timothy Robishaw, & Amanda Kepley

*heiles@astro.berkeley.edu; robishaw@physics.usyd.edu.au; kepley@virginia.edu*

## ABSTRACT

We describe the **Robishaw/Heiles GBT Polarization** (RHGBTPOL) IDL software used at the GBT to derive Mueller matrix parameters and beam properties in all Stokes parameters. The input calibration data can be either Spider scans or ON/OFF scans. We explain how to make a file that contains the Mueller matrix information that is used to polarization-calibrate subsequent observations. The memo on reducing All-Stokes continuum and line data (Heiles, Robishaw, & Kepley 2009) describes how to use the derived Mueller matrix together with additional calibration information to properly calibrate astronomical observations in all four Stokes parameters.

**There are some questions, all marked with four asterisks \*\*\*\*: one group of questions concerns what rcvr files to use (we should use the default ones except for the circpol example in 8-10 GHz); the other, the AAK/TR/CH questions/comments.**

**\*\*\*\*TIM\*\*\*\* The default rcvr files need to be properly made!**

# REDUCING ALL-STOKES CONTINUUM AND SPECTRAL-LINE DATA WITH THE ROBISHAW/HEILES GBT POLARIZATION (RHGBTPOL) IDL SOFTWARE

DRAFT, May 11, 2009

Carl Heiles, Timothy Robishaw, & Amanda Kepley

*heiles@astro.berkeley.edu; robishaw@physics.usyd.edu.au; kepley@virginia.edu*

## ABSTRACT

We describe using the **Robishaw/Heiles GBT Polarization (RHGBTPOL)** IDL calibration software to reduce all-Stokes GBT data taken with the Spectral Processor or the Green Bank Spectrometer—both continuum and spectral-line data. Our description has three levels: (1) the steps and their associated IDL procedures; (2) an explanation of what the steps and programs actually do, together with some commentary and warnings; and (3) two examples, which a user can run in IDL to see how things work.

# REMEMBER THIS # 1: AVERAGING LINEAR POLARIZATIONS!!!

Suppose you average two polarization observations together:

Observation 1 has  $p = 13.6\%$  and  $\chi = 2^\circ$

Observation 2 has  $p = 13.7\%$  and  $\chi = 178^\circ$

NOTE THAT THE POSITION ANGLES AGREE TO WITHIN 4 DEGREES.

If you average  $p$  and  $\chi$ , you get  $p = 13.65\%$  and  $\chi = 90^\circ$ .

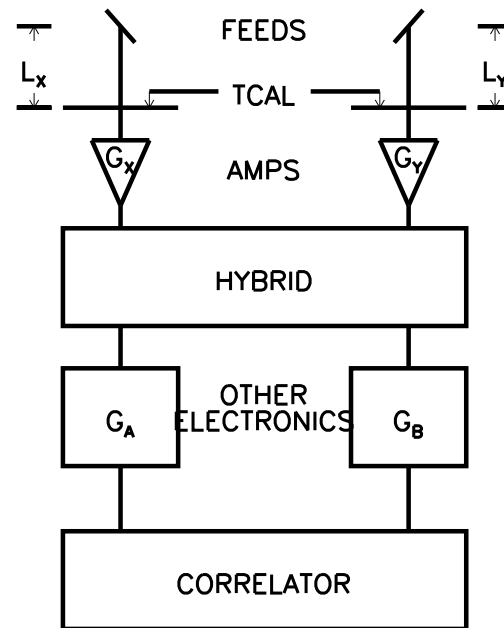
===== **THIS IS INCORRECT!!!!!!!!!!** =====

There is only one *proper* way to combine polarizations, and that is to use the Stokes parameters. The reason is simple: because of conservation of energy, powers add and subtract.

What you must **always** do is **convert the fractional polarizations and position angles to Stokes parameters, average the Stokes parameters, and convert back.**

## REMEMBER THIS # 2: SHOULD YOU GENERATE CIRCULARS WITH A POST-AMP HYBRID???

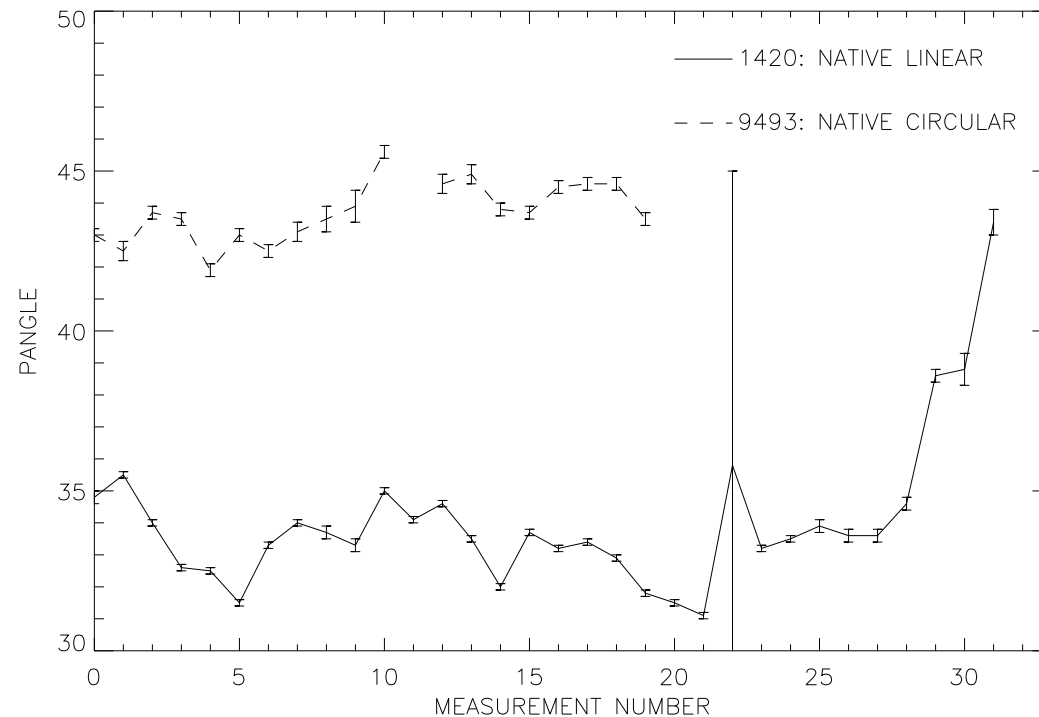
Some astronomers believe that source fluxes (that's Stokes  $I$ ) are better measured with circular polarization. Receiver engineers accommodate them with a post-amp hybrid:



Using this system properly requires a much more complicated calibration procedure. Example: If  $G_y = 0$ , the system still appears to work!!

**JUST SAY NO!!!!!!**

# REMEMBER THIS #3: CROSSCORRELATION VERSUS DIFFERENCING!!!



Look at the wild fluctuations for the 1420 MHz position angle measurement (native linear—differencing). This *NEVER* happens with crosscorrelation (9495 MHz). Crosscorrelation is also less noisy (At 1420 MHz 3C286 is  $\sim 1.5T_{sys}$ ; at 9493 MHz 3C286 is  $\sim 0.5T_{sys}$ ).